

PLANTA BAJA-DISTRIBUCION

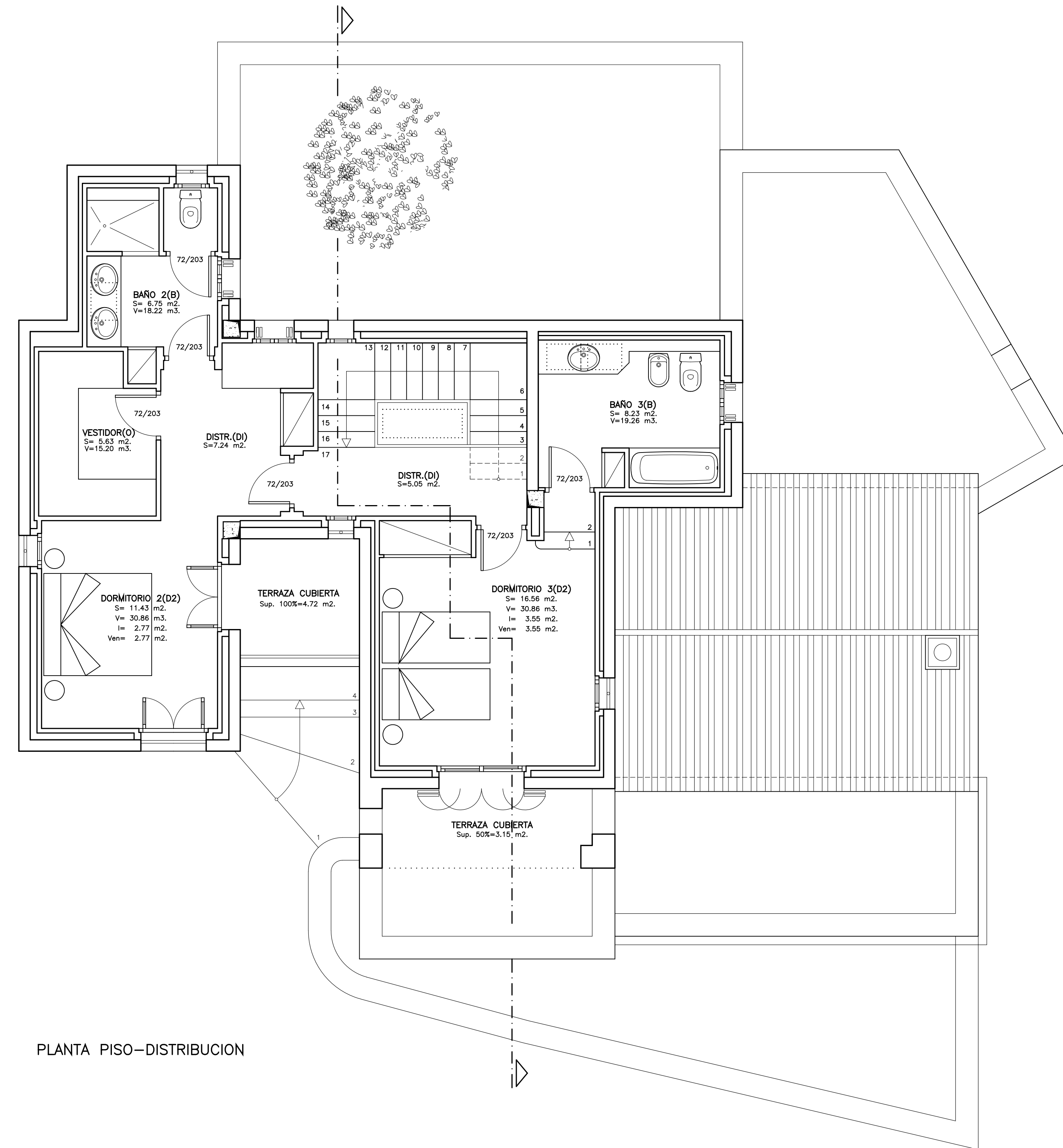

PLANTA PISO-DISTRIBUCION

CUADRO DE SUPERFICIES

VIVIENDA	SUPERFICIE ÚTIL	SUPERFICIE CONSTRUIDA CERRADA	SUPERFICIE TERRAZAS CUBIERTAS	SUPERFICIE CONSTRUIDA TOTAL
PL. BAJA	121,61 m <sup>2</sup> .	161,11 m <sup>2</sup> .	13,68 m <sup>2</sup> .	174,79 m <sup>2</sup> .
PL. PRIMERA	60,89 m <sup>2</sup> .	90,56 m <sup>2</sup> .	7,87 m <sup>2</sup> .	98,43 m <sup>2</sup> .
TOTAL	182,50 m <sup>2</sup> .	251,67 m <sup>2</sup> .	21,55 m <sup>2</sup> .	273,22 m <sup>2</sup> .

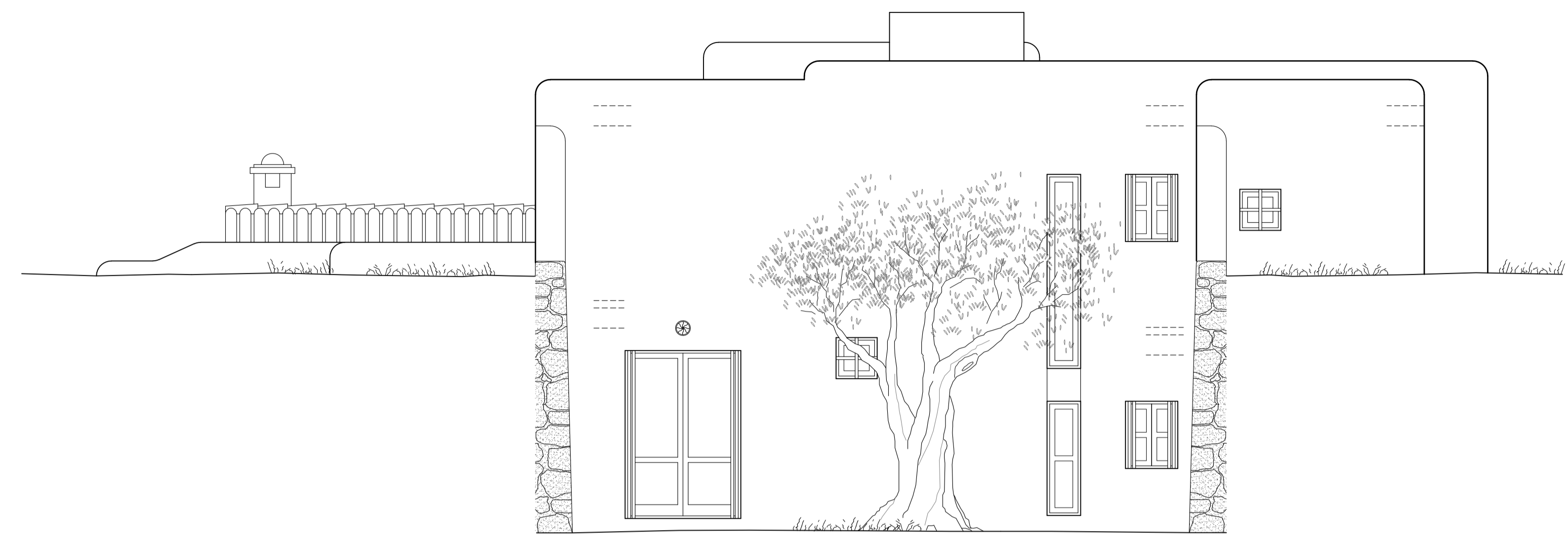

ALZADO OESTE.



ALZADO ESTE.

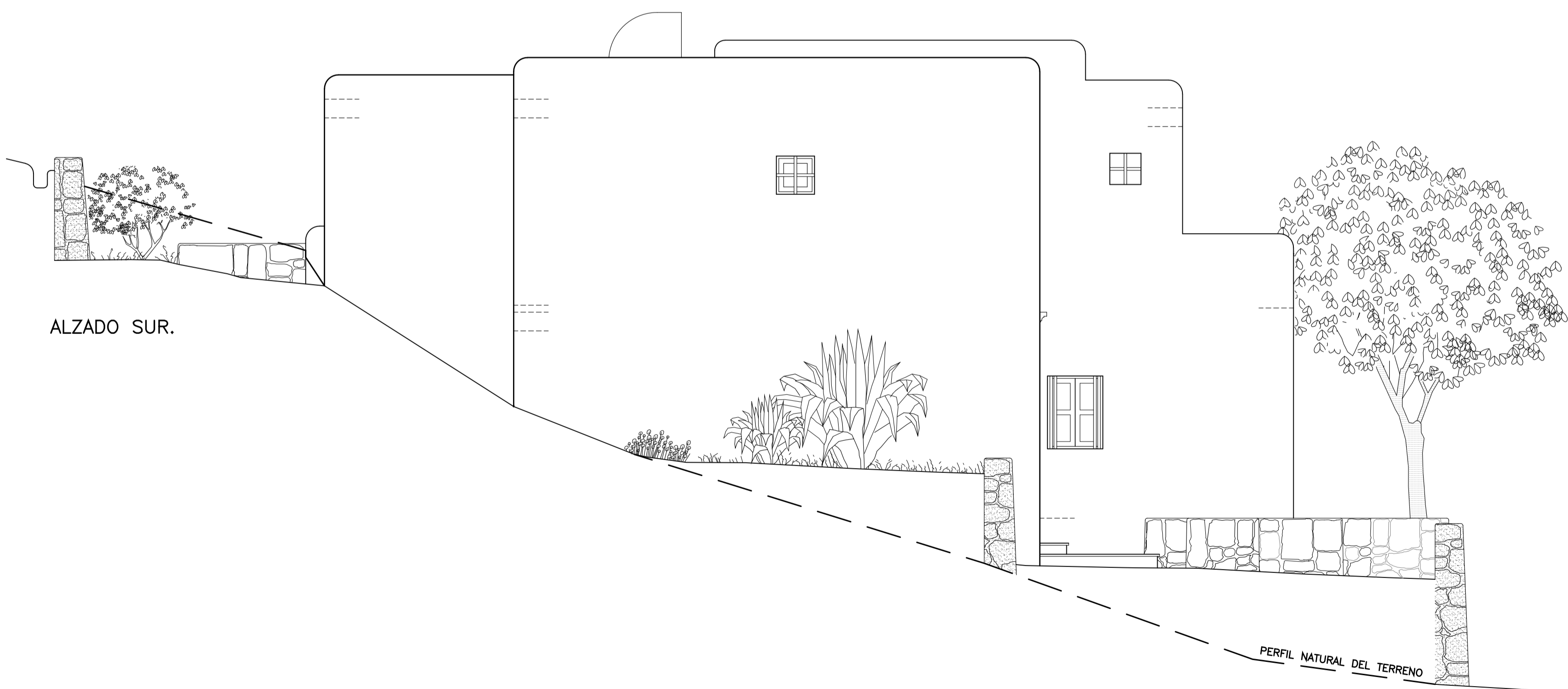

ALZADO SUR.



ALZADO NORTE.

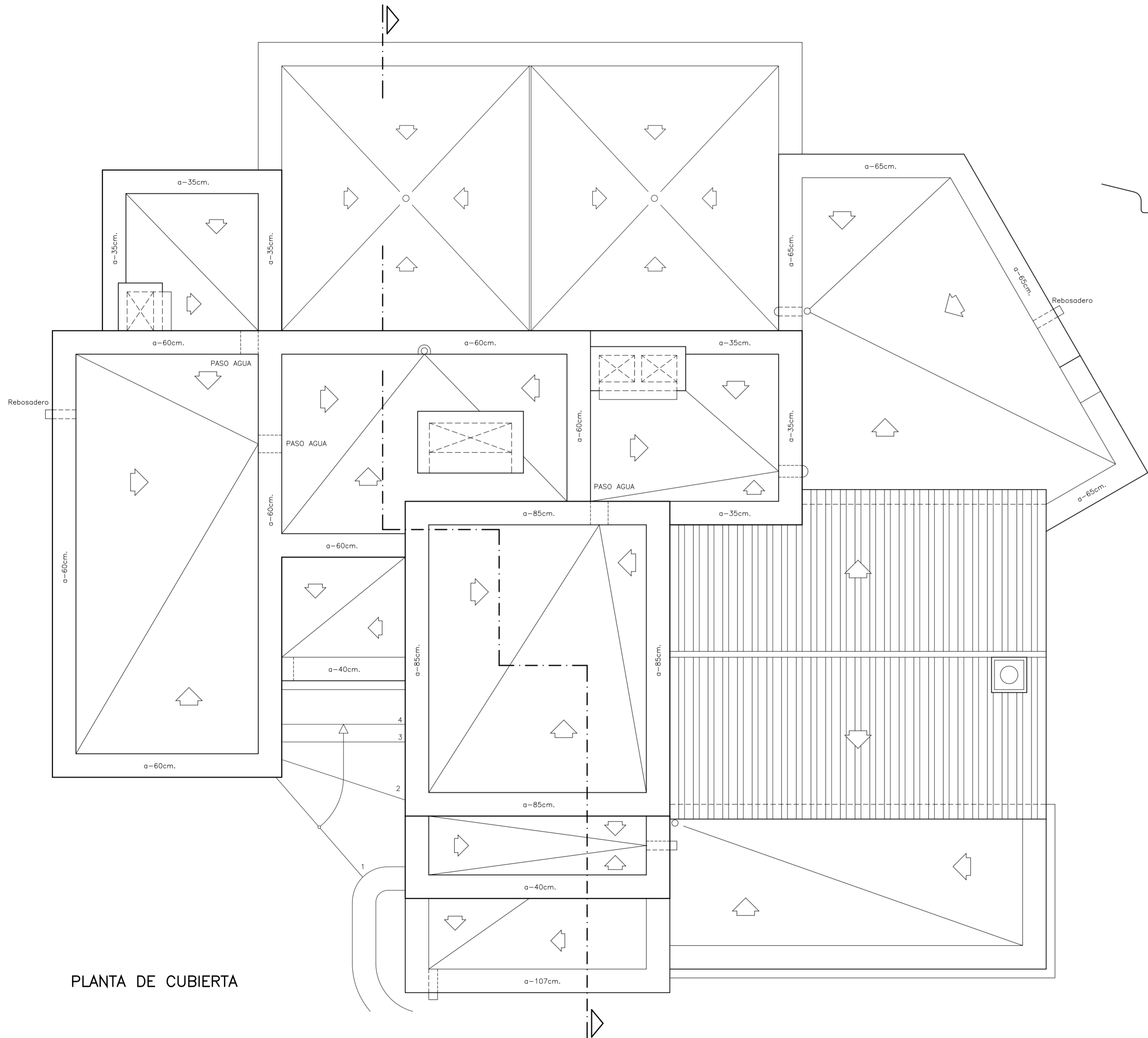

PLANTA DE CUBIERTA

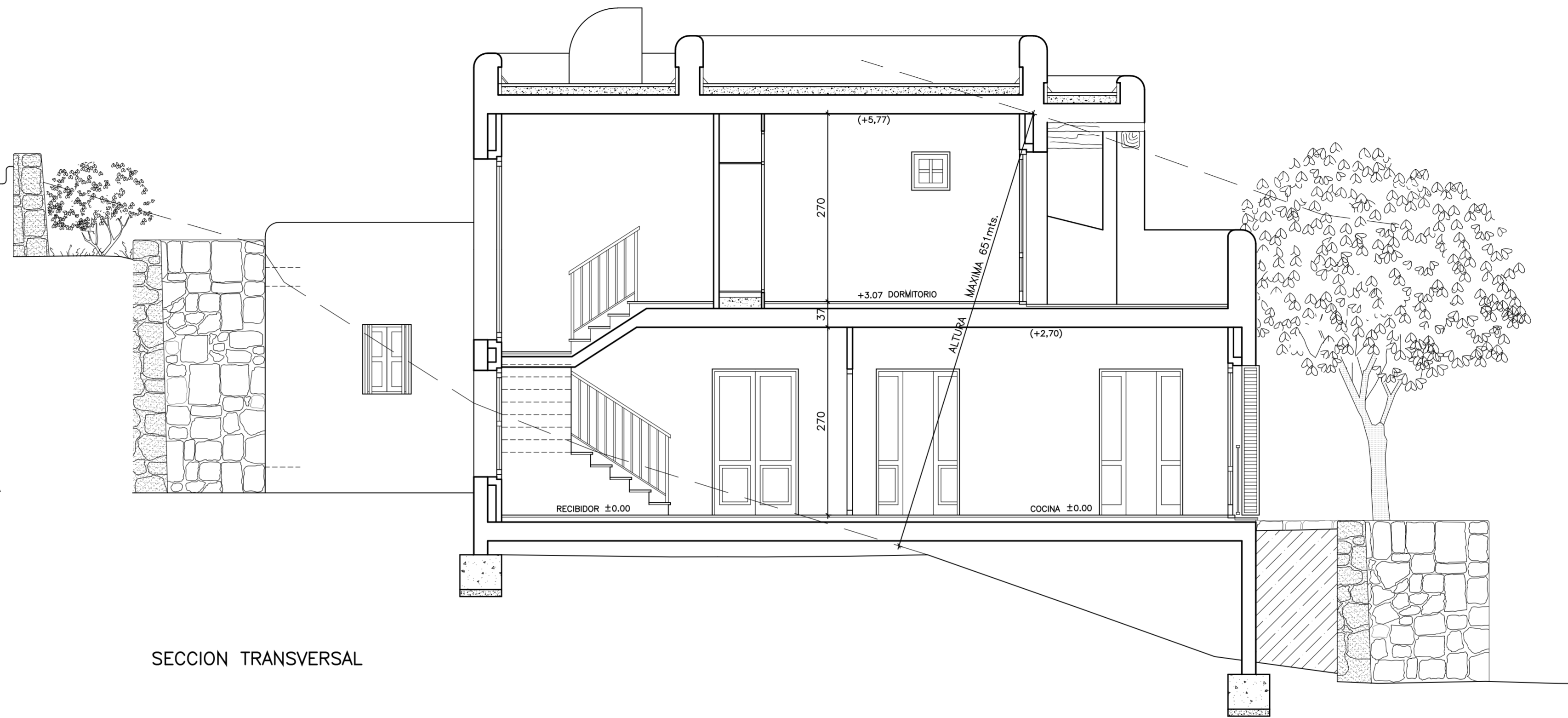

SECCION TRANSVERSAL

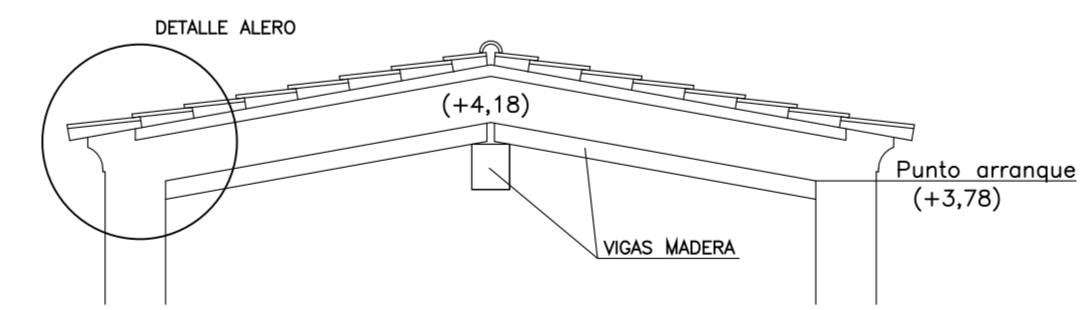

DETALLE CUBIERTA SALON  
FORJADO INCLINADO CON 18% DE PENDIENTE  
CON VIGAS FALSAS DE MADERA POR DEBAJO

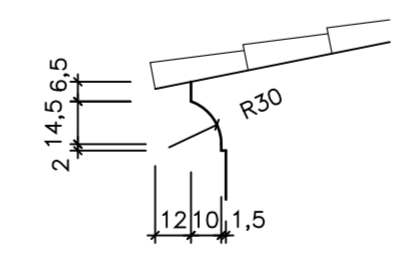

DETALLE ALERO TEJA.